

Tutorial on Conformance and Interoperability Testing

SG 17 Informal Tutorial on CIT

**Ostap Monkewich,
Vice-Chairman ITU-T SG 17
December 8, 2006**

Purpose of this tutorial

- **To present key CIT terms, concepts and the technical CIT language**
- **To identify ITU-T CIT Recommendations which already exist**
- **To identifying what additional, new Recommendations are needed**

Conformance Testing Methodology Recommendations

- **X.290 - General Concepts**
- **X.291 - Abstract Test Suite Specification**
- **X.292 - Tree and Tabular Combined Notation**
- **X.293 - Test Realization**
- **X.294 - Requirements on Test Laboratories and Clients**
- **X.295 - Protocol Profile Test Specification**
- **X.296 - Implementation Conformance Statements**

Notation for Description of Test Suites and Test Methods

- **TTCN-1**
 - **Tree and Tabular Combined Notation Edition 1**
 - **ISO/IEC 9646-3 (1995)**
 - **ITU-T Recommendation X.292 (1995)**
 - **Non-concurrent TTCN**
- **TTCN-2**
 - **Tree and Tabular Combined Notation Edition 2**
 - **ISO/IEC 9646-3 (1998)**
 - **ITU-T Recommendation X.292 (1998)**
 - **Concurrent TTCN**
- **TTCN-3**
 - **Testing and Test Control Notation Three (2003-2006)**
 - **ITU-T Recommendations Z.140 through Z.146**

Why Do We Need A Common Testing Methodology

- **Test laboratories, accreditation and certification organizations use the same terms, definitions and criteria**
- **Comparison of test results by the buyer**
- **Acceptance of test results in all global regions**
- **One set of tests - no retesting in different markets**

Why Conformance to Standards is important?

- **Conforming implementations of the same standard have a higher degree of interoperability**
- **Different vendors can independently implement standards with a high degree of assurance of product interoperability**
- **Buyers can shop around for best-buy products and not lose their previous investment**

Why Interoperability is important?

- **The ultimate objective is that independent implementations of the same standard interoperate**
- **Conformance improves the chances of interoperability while interoperability testing checks at a user level if interoperability has been achieved**

Conformance and Interoperability are Complementary

- **Conformance to the standard is achieved first and should not be compromised during Interoperability testing**
- **Without conformance, two implementations can be made to interoperate by destroying interoperation with all other systems**

Causes of Interoperability Problems

- **Standards**
 - Errors and ambiguities in standards
 - Incompatible standards (standards with different QoS, traffic priorities)
- **Implementations**
 - Human errors, e.g. programmer errors
 - Different interpretations of the standard
 - Different choice of options allowed by the standard
- **Technology**
 - networks use different traffic queuing techniques
 - device compatibility
 - host system configuration

Nature of Interoperability Testing

- **Interoperability testing is only meaningful in single-pair combinations of products**
- **N interconnected products present $(N^2 - N)/2$ distinct product pair combinations**

- **Example:**

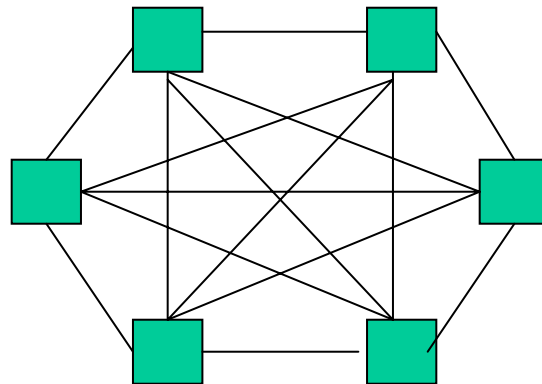

- **N = 6 products or 15 pairs**
- *Each product is tested 15 times*
- **N = 100 or ~5000 pairs**
- *Each product is tested 5000 times*

Nature of Conformance Testing

- **Testing to determine if the product does what the Recommendation says it is supposed to do**
- **Each product is tested only once, against the standard (represented by the test suite)**



Overview of Conformance Testing

1. Static Review
2. Dynamic Tests
3. Test Report
4. Certification

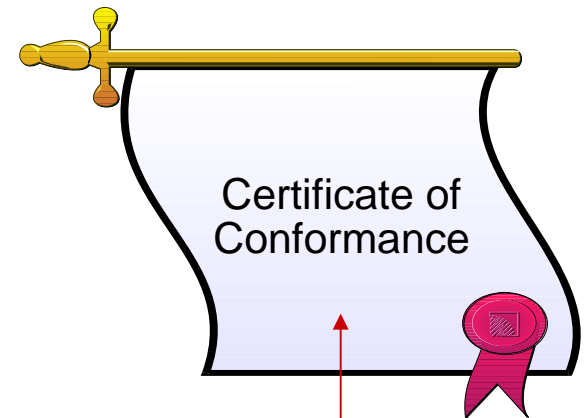

Test Report

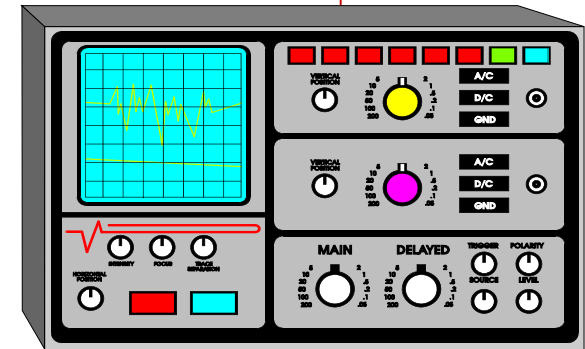

Test Equipment and Test Suite

Implementation with a formal declaration of which parts of the standard were implemented

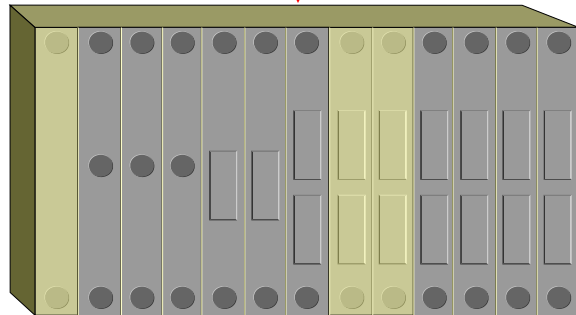

Implementation Under Test (IUT)

STIMULUS



RESPONSE



Static vs Dynamic Testing

- **Static (PICS review)**
 - what mandatory, optional or conditional features of the protocol were implemented - declared in the PICS proforma by the supplier
 - PICS becomes a shopping list for finding compatible products
 - a car PICS analogy:
 - does the car have an ignition system?
 - does the car have a steering wheel?
- **Dynamic (execution of the ATS)**
 - behaviour of mandatory, optional or conditional features
 - a car ATS analogy
 - turn the ignition key, does the engine turn over? Pass, Fail, Inconclusive
 - turn the steering wheel, do the front wheels turn? Pass, Fail, Inconclusive

A Requirements Clause from a Standard

Extract from the User-Network Interface (UNI) Specification 3.1

3.3 ATM Cell Structure and Encoding at the UNI

- (R) CPE at the UNI shall encode the GFC value to all zeros (0000).
Public network equipment at the public UNI shall encode the**
- (R) GFC value to all zeros (0000).
CPE shall inform Layer Management if a count of the non-zero**
- (O) GFC fields measured for non-overlapping intervals of 30,000 +/-
10,000 cell times reached ten (10) or more.
Public network equipment shall inform Layer Management if a**
- (O) count of non-zero GFC fields measured for non-overlapping
intervals of 30,000 +/- 10,000 cell times reaches ten (10) or more.**

Protocol Implementation Conformance Statement (PICS) Proforma

Extracted from af-test-0059.000: PICS Proforma for the UNI 3.1 ATM Layer

3.5 Generic Flow Control (GFC) Field

Index	Text	Status	Ref.	Values	Support
3.5.1	Does the IUT operate the GFC protocol in "uncontrolled access" mode, encoding the GFC field to be all zeros?	M	3.3		__Yes__No
3.5.2	If the IUT is an intermediate node, does the IUT overwrite any non-zero GFC field received before sending it into the network?	M	3.3		__Yes__No
3.5.3	Does the IUT, on receipt of 10 or more non-zero GFC fields measured for non-overlapping intervals over 30000+/-10000 cell times, generate an error to layer management?	O	3.3		__Yes__No

Static Review

- **ICS Proforma - Implementation Conformance Statement Proforma**
 - formatted questionnaire for declaring what optional features have been implemented
 - part of the specification or standard
- **ICS**
 - Filled-out ICS Proforma
 - A list of requirements and options claimed to have been implemented
- **Used for**
 - Shopping list for matching products for interoperability
 - Test case selection (from test suite) for execution

PICS	
<input checked="" type="checkbox"/>	1. Sta
<input type="checkbox"/>	2. Ch
<input type="checkbox"/>	3. Bu
<input checked="" type="checkbox"/>	4. Wo
<input checked="" type="checkbox"/>	5. Ma
<input type="checkbox"/>	6. Try
<input type="checkbox"/>	7. Te:
<input type="checkbox"/>	8. Ex

Dynamic Tests

- **Abstract Test Suite (ATS)**
 - **Defined by a standards organization, written in an abstract language like**
 - **Tree and Tabular Combined Notation (TTCN-1, TTCN-2), ISO/IEC 9646, ITU-T X.292**
 - **Testing and Test Control Notation (TTCN-3), ITU-T Rec. Z.140**
- **Executable Test Suite (ETS)**
 - **AT .mp file “compiled” to run on specific test equipment**
 - **creation of the ETS is proprietary to the test equipment vendor**

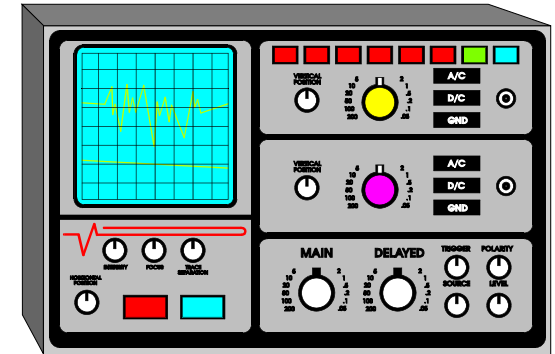

The Local Test Method

There are two PCOs. UT and LT both reside on the Test System. The upper boundary of the IUT is standardized hardware interface that plugs into the Test System.

UT Upper Tester

LT Lower Tester

PCO Point of Control and Observation

IUT Implementation Under Test

SUT System Under Test

ASP Abstract Service Primitive

PDU Protocol Data Unit

TCP Test Coordination Procedure

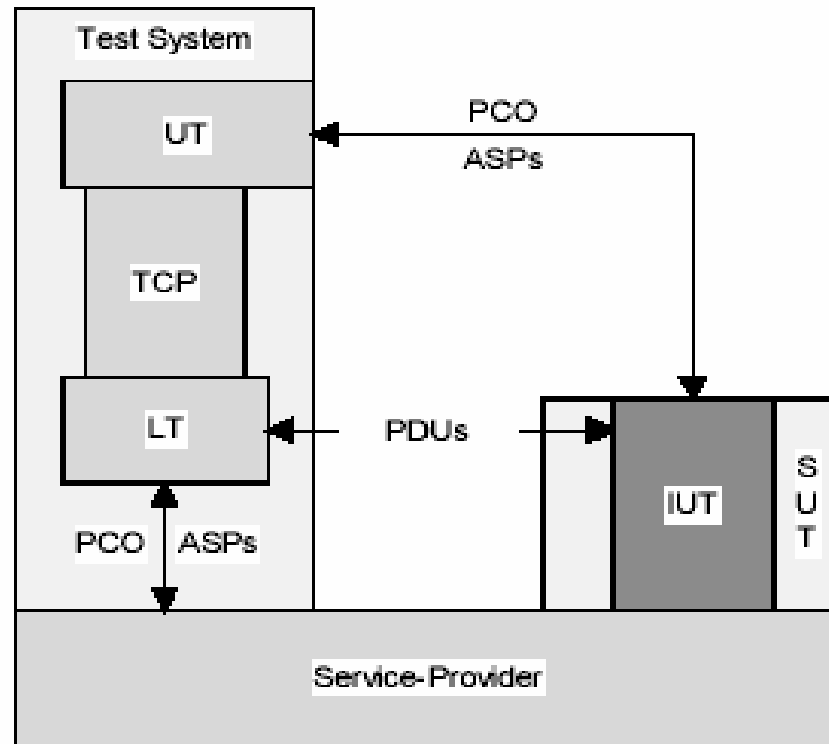

The Distributed Test Method

There are two PCOs. The UT is located in the SUT. The LT is located in the Test System. Access to the upper boundary of the IUT is required to carry out testing either by human action or a programming interface.

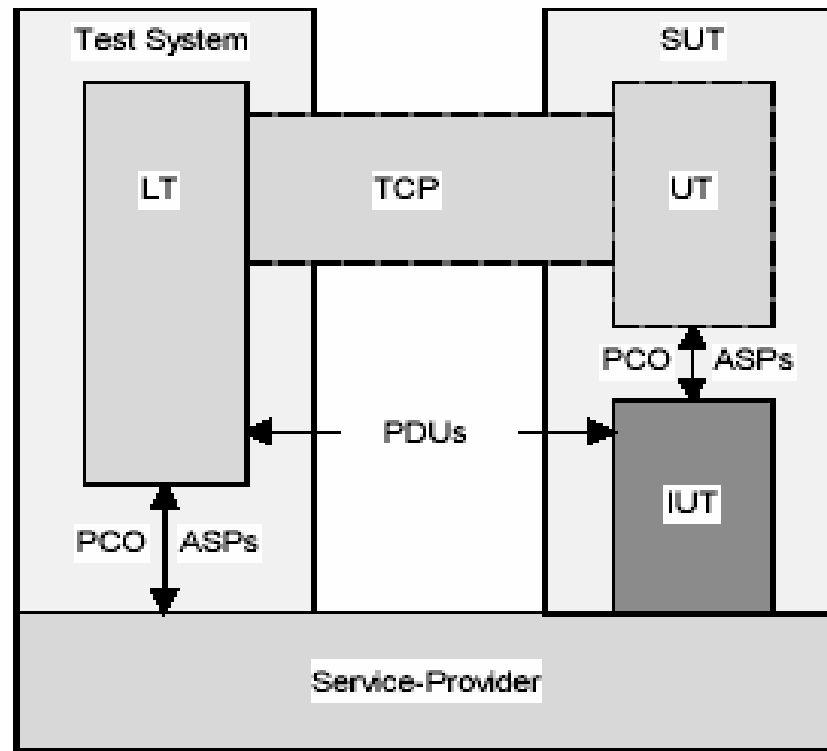

The Coordinated Test Method

There is only one PCO and no UT. UT is integrated with TCP. The desired effects at the upper boundary of the IUT are realized by a special TCP called the standardized Test Management protocol. The method facilitates the highest degree of automation and security.

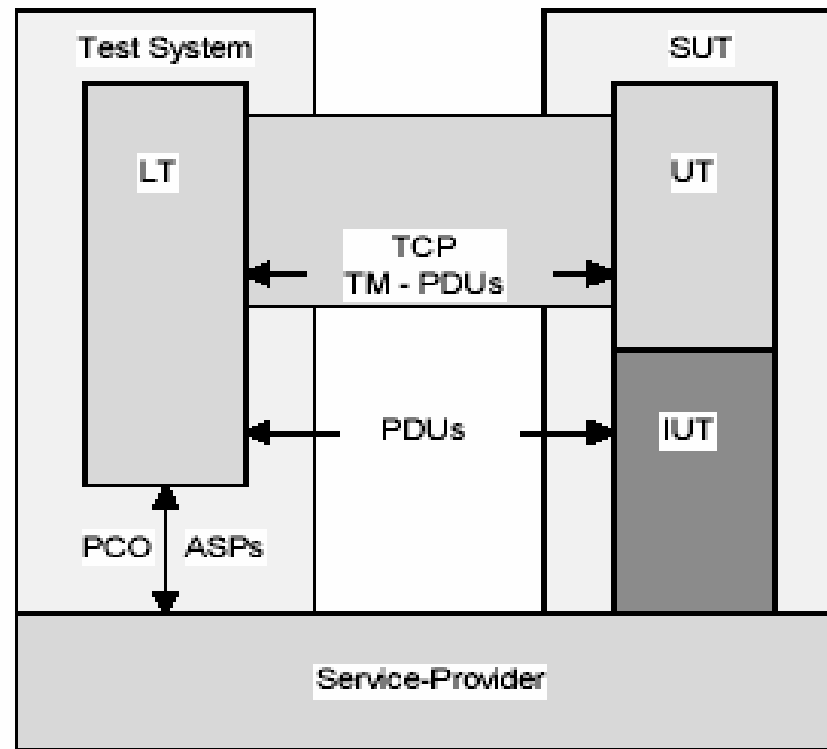

The Remote Test Method

There is only one PCO and no UT or TCP. The Tester has no access to the upper boundary of the IUT. The desired effects at the upper boundary are informally described in the test suite and are carried out at the SUT by the test operator

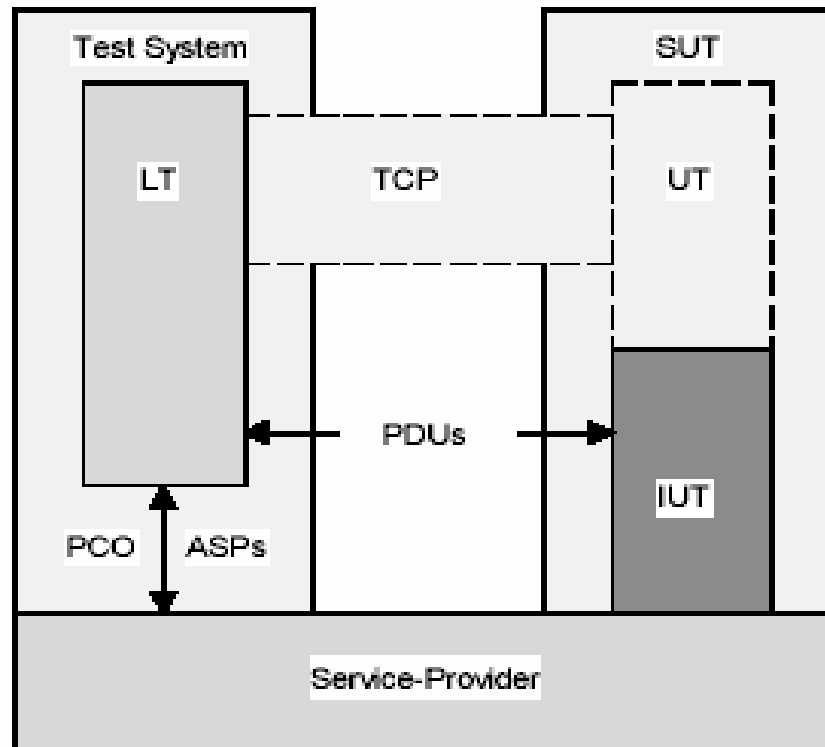

What is a Test Suite?

- A *test suite* is a collection of *test cases*, one for each test purpose, specified in accordance to the test method used
- A test case verifies *conformance/interoperability* for a particular Requirement or Option according to the *test purpose*

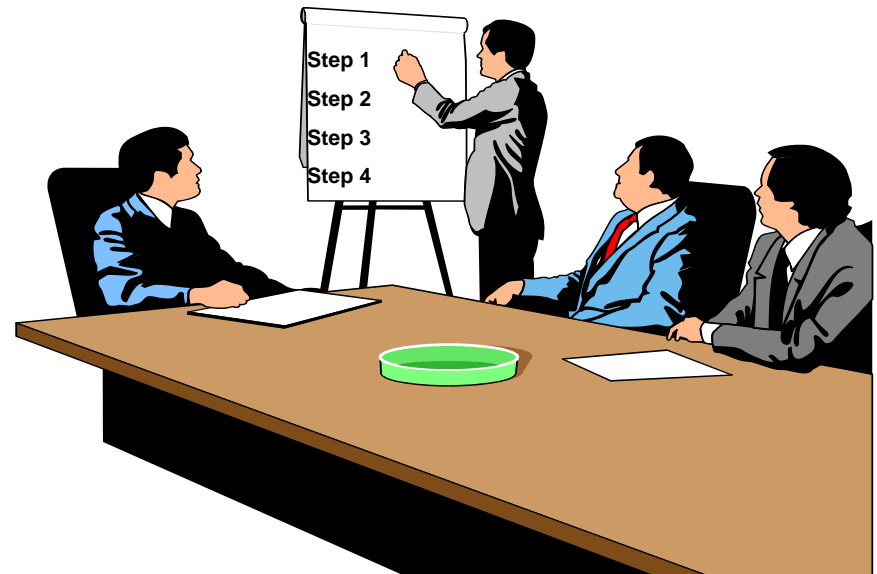

Test Suite Development

- Start with a *PICS*
 - This ensures that complete coverage is obtained
- Develop *Test Suite Structure*
 - This logically groups the test cases
- Develop *Test Purposes*
 - This defines the objectives of the *test cases*
- Write a *Test Case* for each Test Purpose
 - The *test purpose* is then included with its test case in the test suite



Test Suite Structure

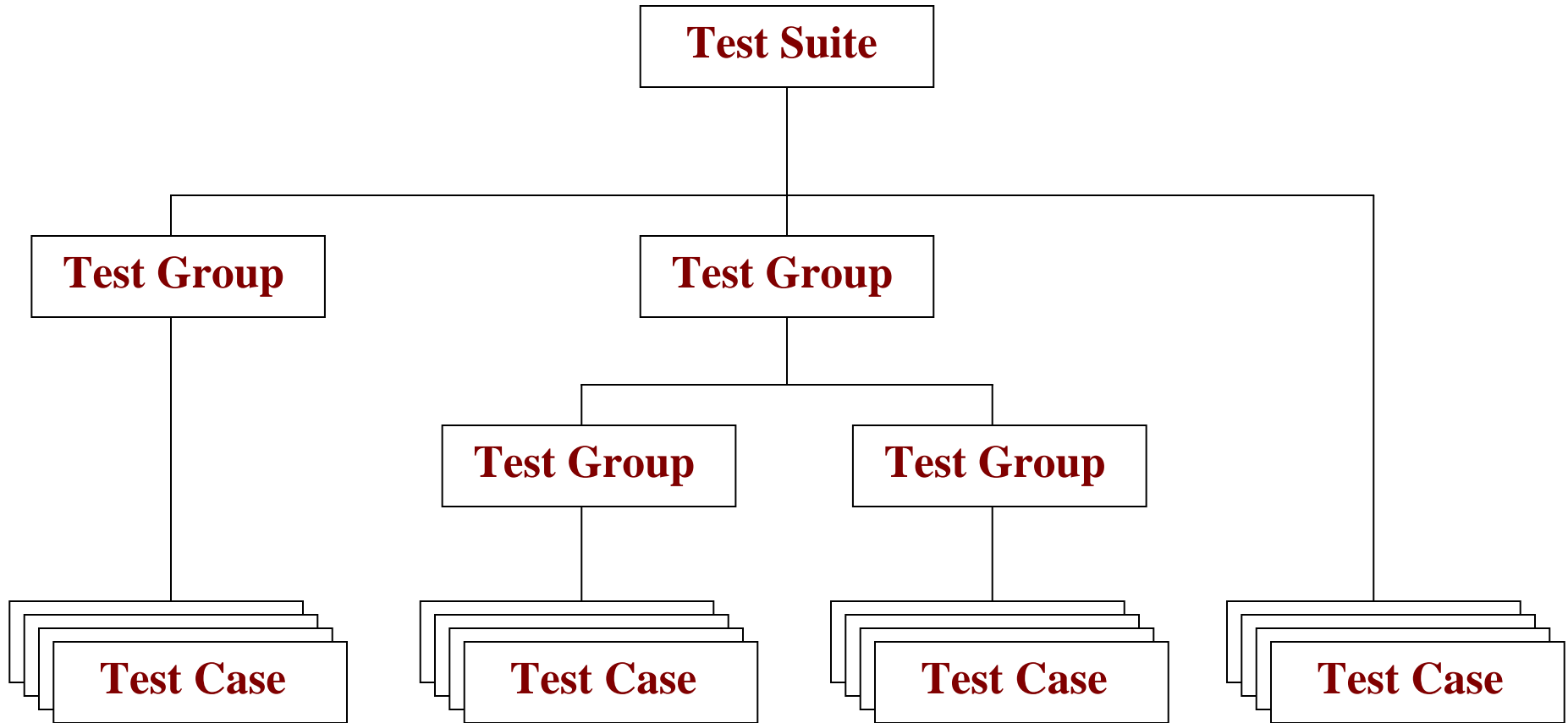

Test Case Structure

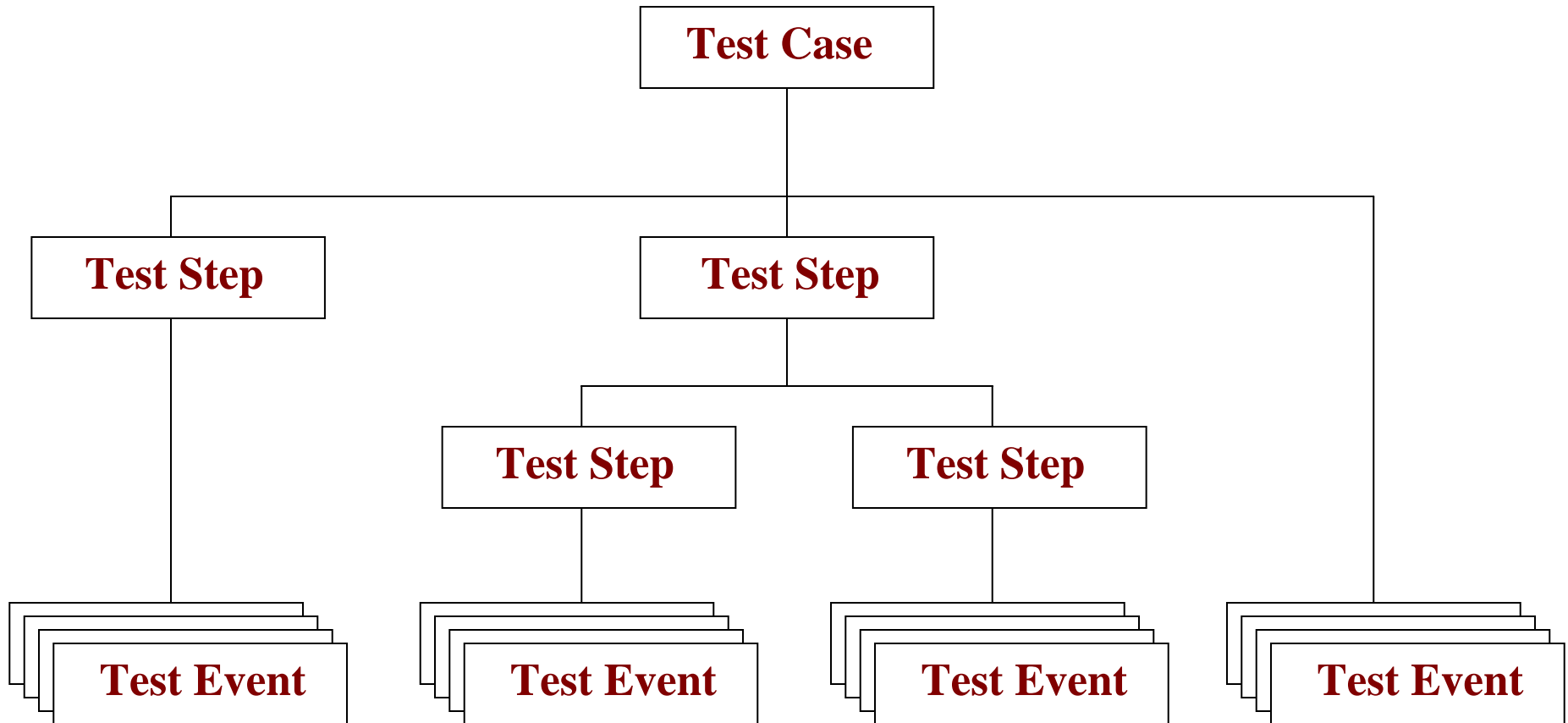

Test Cases, Test Purposes and Verdicts

- One Test Case for each Test Purpose representing one Requirement from the Requirements Clause
- To get a **Pass** verdict, the Implementation Under Test (IUT) must respond correctly when the Tester exhibits three different kinds of behaviour:
 - **Valid**
 - **Invalid**
 - **Inopportune**
- For each of the three Tester behaviours, the IUT may be assigned a **Pass, Fail or Inconclusive** verdict

ATS Test Case in TTCN-2

Test Case Dynamic Behavior					
Test Case Name : Ver_Gen_GFC0_VC Group : General/ Purpose : Verify that the IUT encodes all GFC bits to '0' in a VCC Default : Comments : Requires a VC connection. Ref 3.3/PICS 3.5.1					
Nr	Label	Behavior Description	Constraints Ref	Verdict	Comments
1		<IUTICELL>	USER_CELL(VPIvcc,VCivcc)		Request that the IUT sends a general user data cell on VCC.
2		START T_Opr			
3		(GFC_VAL:='0000'B)			
4	LB1	LT_PCO?CELL	USER_CELL(VPIvcc,VCivcc)		
5		[CELL.GFC=GFC_VAL]		Pass	GFC='0000'
6		[CELL.GFC<>GFC_VAL]		Fail	GFC<>'0000'
7		LT_PCO?CELL	CELL_UNASSIGNED		
8		GOTO LB1			
9		?TIMEOUT T_Opr		Incon	Inconclusive - timeout
10		LT_PCO?OTHERWISE		Fail	
Detailed Comments : Selection Ref:SEND_USER_CELL_VC (answered 'yes' in PIXIT question 8 : Can the IUT be forced to send a User data cell on demand (User_Cellpar)?)					

Extract from the "graphical" (.gr) output from
 af-test-0060.000: Conformance Abstract Test Suite
 for the UNI 3.1 ATM Layer of End Systems

Example TTCN-3 Format

```
function PO49901(integer FL) runs on MyMTC
{
  L0.send(A_RL3(FL,CREF1,16));
  TAC.start;
  alt {
    [] L0.receive(A_RC1((FL+1) mod 2)) {
      TAC.cancel;
      verdict.set(pass)
    }
    [] TAC.timeout {
      verdict.set(inconc)
    }
    [] any.receive {
      verdict.set(fail)
    }
  }
  END_PTC1() // postamble as function call
}
```

Extra Information for Testing

- **IXIT - Implementation eXtra Information for Testing**
 - **Additional information required before testing can proceed**
 - **administrative: identification of client, laboratory staff, IUT, protocol, test suite**
 - **technical: address of the IUT, timer values, configuration, parameters, procedures, test cases that cannot be executed**
- **IXIT Proforma**
 - **Standardized template to be completed by the client and the test laboratory to produce the IXIT**
- **PIXIT - Protocol IXIT**
 - **A special case of IXIT, widely used**

Protocol and Test Specification Using Formal Languages and Tools

- **Protocols specifications expressed in SDL can be shown to be error-free and have the expected behaviour**
 - Validation of the specification
 - Simulation of the behaviour
- **Test suites in TTCN can be generated automatically from SDL specifications**

Standards that Facilitate Testing

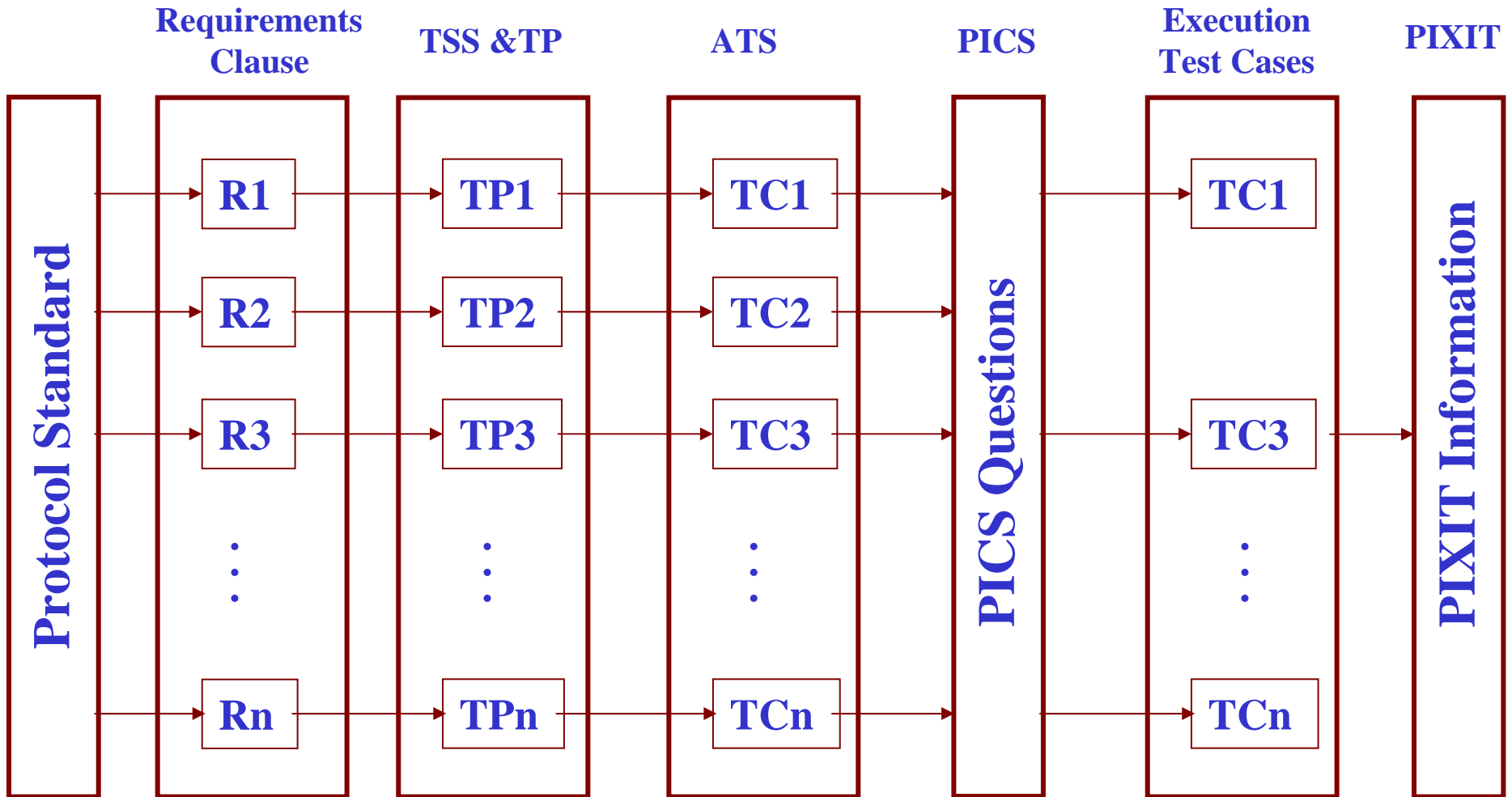

TSS & TP - Test Suite Structure and Test Purposes

ATS: - Abstract Test Suite

PICS: - Protocol Implementation Conformance Statement

TP - Test Purpose

TC - Test Case

R - Requirement

What Standards are Missing Today

- **For each Protocol**
 - **Requirements Clauses**
 - **TSS&TP**
 - **PICS and ICS Proformas**
 - **PIXIT and IXIT Proformas**
 - **Abstract Test Suites**

Interoperability Testing

- A *method* for determining to what extent *two or more* implementations *function together* for some range of applications over a specific communications medium



General Configuration for Interoperability Testing

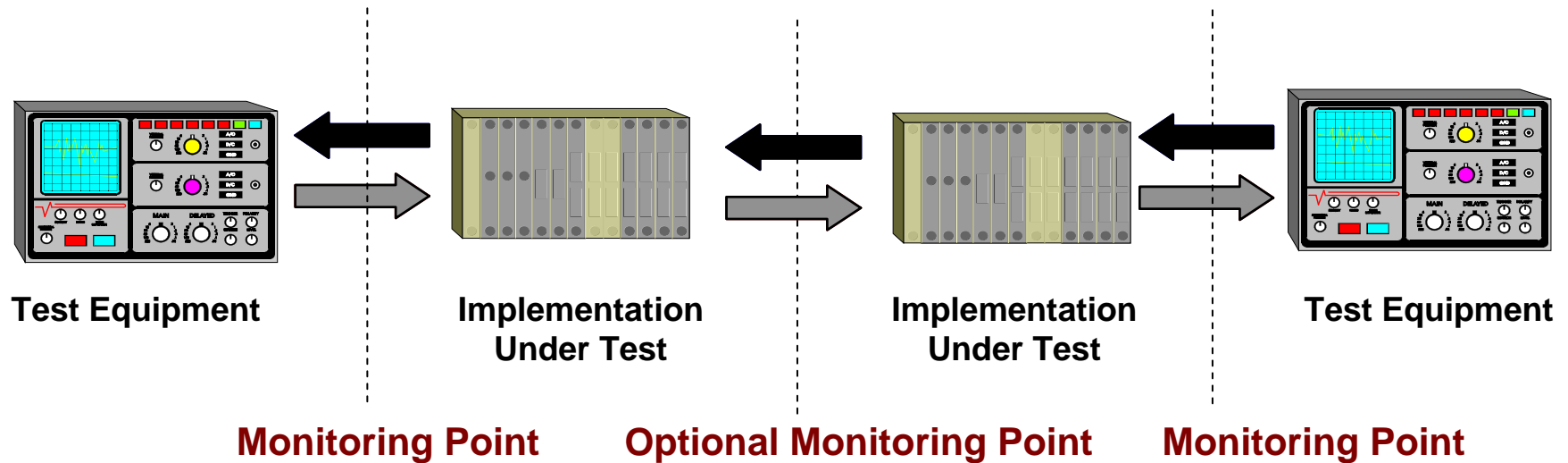

An Interoperability Test Case

**Extract from af-test-0035.000: Interoperability
Abstract Test Suite for the ATM Layer**

Test Case ID: ATM/Cell Relay/6

Test Case Name: Interoperability in the “uncontrolled access” mode, VCC.

Test Purpose: To verify interoperability in the “uncontrolled access” mode on VCC.

Pre-requisite: Run if SUTs implement VCC.

Reference: [1], Section 3.3

Test Configuration: #1

Test Set-up:

1. Establish at least 3 bi-directional VCCs between Testers A and B.

Test Procedure:

1. Tester A generates a cell stream with GFC field set to 0 of test traffic type H for each VCC.
2. Tester B monitors the received cell stream.
3. Repeat this test with the relative positions of SUTs A and B interchanged.

Verdict Criteria:

All cells inserted at the originating end points shall appear in the terminating end points of VCCs

Interoperability Testing Standards

- **Z.itfm series Recommendations on Methodology**
 - work in progress
 - two major contributions - ETSI, Korea
 - similar methodology to X.290 Recommendation
 - some new concepts are being discussed
- **Standards to be produced as required by Z.itfm**
 - Requirements Clause
 - Test Suite Structure and Test Purposes (TSS&TP)
 - Implementation Conformance Statement (ICS)
 - The Abstract Test Suite
 - Implementation eXtra Information for Testing (IXIT)

What Standards are Missing

- **Methodology and Framework**
 - Test procedures, test methods etc. are yet to be defined
 - TTCN is likely to be sufficient for specifying Interoperability test suites
- **For each Protocol**
 - Requirements Clauses
 - TSS&TP
 - PICS and ICS Proformas
 - PIXIT and IXIT Proformas
 - Abstract Test Suites

Trusting the Test Results

- **Who does the testing**
 - **Third-party testing (independent test laboratory)**
 - **Second-party testing (product procurer or user)**
 - **First-party testing (product supplier)**
- **Testing can be made formal enough for certification of tested products**

Adding Confidence

- **Accreditation**
 - checks for competence to carry out testing
 - checks for competence to issue certifications
- **Certification**
 - checks for conformity to a quality system standard
 - checks for conformance to the protocol standard
- **Test Laboratories**
 - Carry out testing
 - Prepare the Test Report

Conclusions

- **Conformance testing improves product quality and chances of product interoperability**
- **Interoperability testing is a check to determine if interoperability of conforming products has been achieved**
- **Conformance testing methodology and framework standard exist but may need to be extended**
- **Interoperability testing methodology and framework standard is being progressed**
- **Supporting standards for conformance and interoperability testing do not exist and no plans are in place to develop them**
- **Standards should be tested for errors and ambiguities prior to approval (as is done in IETF)**
- **Accreditation and Certification are useful for buyer confidence, access to foreign markets and meeting regulatory requirements**